

Sc

KEY STAGE

3

TIER

5-7

Science test

Paper 1

First name _____

Last name _____

School _____

Remember

- The test is 1 hour long.
- You will need: pen, pencil, rubber, ruler, protractor and calculator.
- The test starts with easier questions.
- Try to answer all of the questions.
- The number of marks available for each question is given below the mark boxes in the margin. You should not write in this margin.
- Do not use any rough paper.
- Check your work carefully.
- Ask your teacher if you are not sure what to do.

2009

1. A company has made a new material called 'Wellwarm'. They want to use 'Wellwarm' to make coats.
- (a) A scientist tested 'Wellwarm' to see how well it insulated a beaker of hot water. She tested 'Wellwarm' and three other materials as shown below.

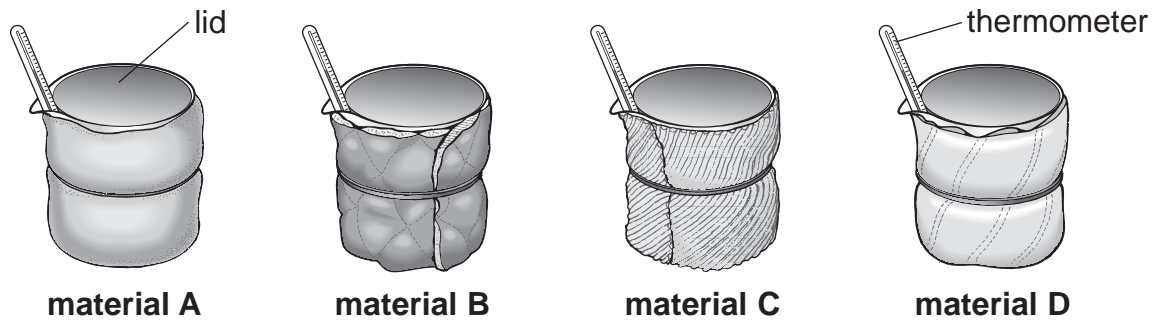

She wrapped each beaker in a different material.
She recorded the temperature at the start and 20 minutes later.

- (i) What was the independent variable that the scientist **changed**?

1ai
1 mark

- (ii) What was the dependent variable that the scientist **measured** during the investigation?

1aii
1 mark

- (b) The results of the investigation are shown below.

time (minutes)	temperature of water (°C) wrapped in			
	material A	material B	material C	material D
0	60	60	60	60
20	34	40	38	36

- (i) The scientist said that the 'Wellwarm' material is the best insulator. Which material was 'Wellwarm'? Use the results to help you. Tick the correct box.

A B C D

1bi
1 mark

- (ii) Use the evidence in the results table to explain your choice.

1bii
1 mark

- (c) The company made a coat from each of the four materials they tested.



A person tested the different coats by wearing each one in a cold room. He measured the temperature inside each coat for 30 minutes.

Write down two **other** variables that should be controlled to make this a fair test.

1. _____

2. _____

1c
1 mark

1c
1 mark

- (d) Write down one thing the scientists should do to make sure the person testing the coats is safe.

1d
1 mark

- (e) Suggest **one** advantage of using a temperature sensor and data logger instead of a thermometer in this experiment.

1e
1 mark

maximum 8 marks

2. (a) The diagram below shows George using his laptop. Light from the lamp is reflected by the laptop screen.

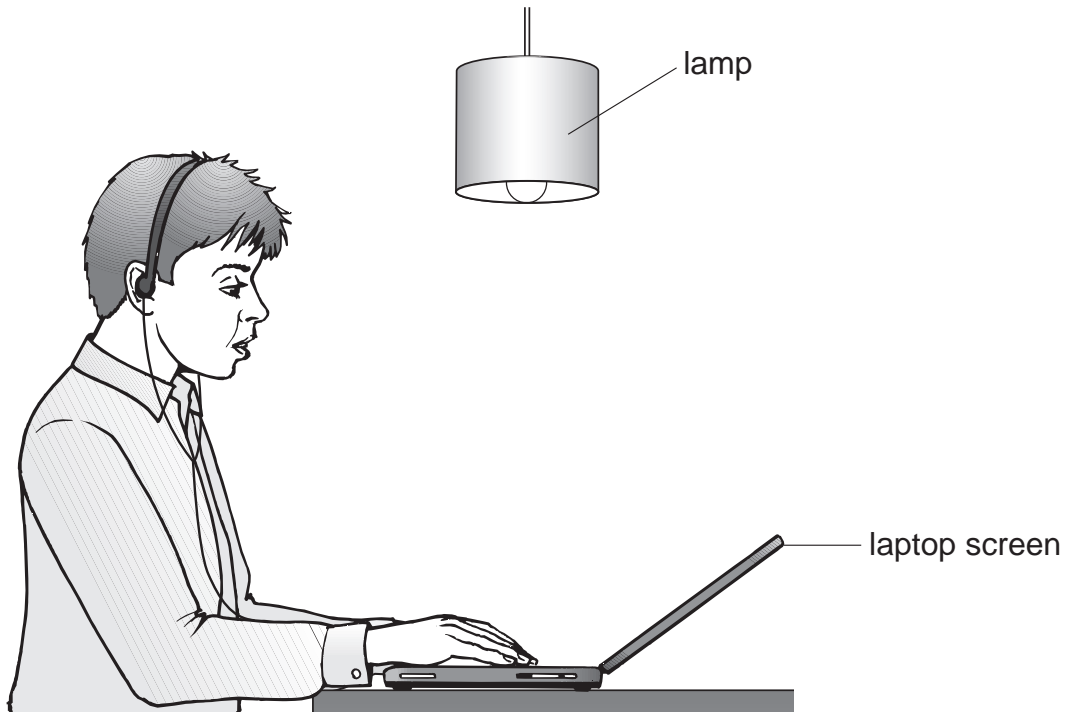

- (i) **On the diagram above** draw a ray of light to show how George sees the light from the lamp reflected by the laptop screen. Use a ruler.

Draw arrows to show the direction of light.

2ai

1 mark

2ai

1 mark

2ai

1 mark

- (ii) With the laptop screen in the position shown in part a(i), George sees an image of the lamp on the screen.
George tilts the screen forwards as shown below.

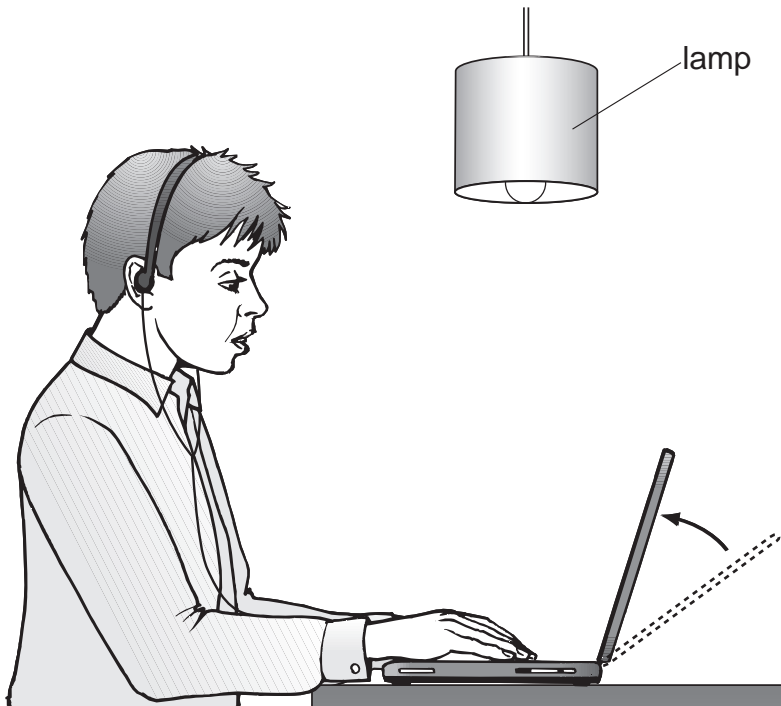

When the screen is tilted forwards it is easier for George to see the words on the screen.
What happens to the reflected ray of light when the screen is tilted?

2ai
1 mark

- (b) George listens to music on his headphones.

Complete the sentence below using words from the box.

chemical	electrical	gravitational potential
sound	thermal	

The useful energy change in the headphones is from _____
energy into _____ energy.

2b
1 mark

maximum 5 marks

3. (a) The diagram below shows the positions of the Sun, Moon and Earth during a solar eclipse.

Write numbers (1–4) on the diagram below to label the features during an eclipse.

1. the Earth
2. the Moon
3. the Sun
4. a region where the total eclipse of the Sun is taking place

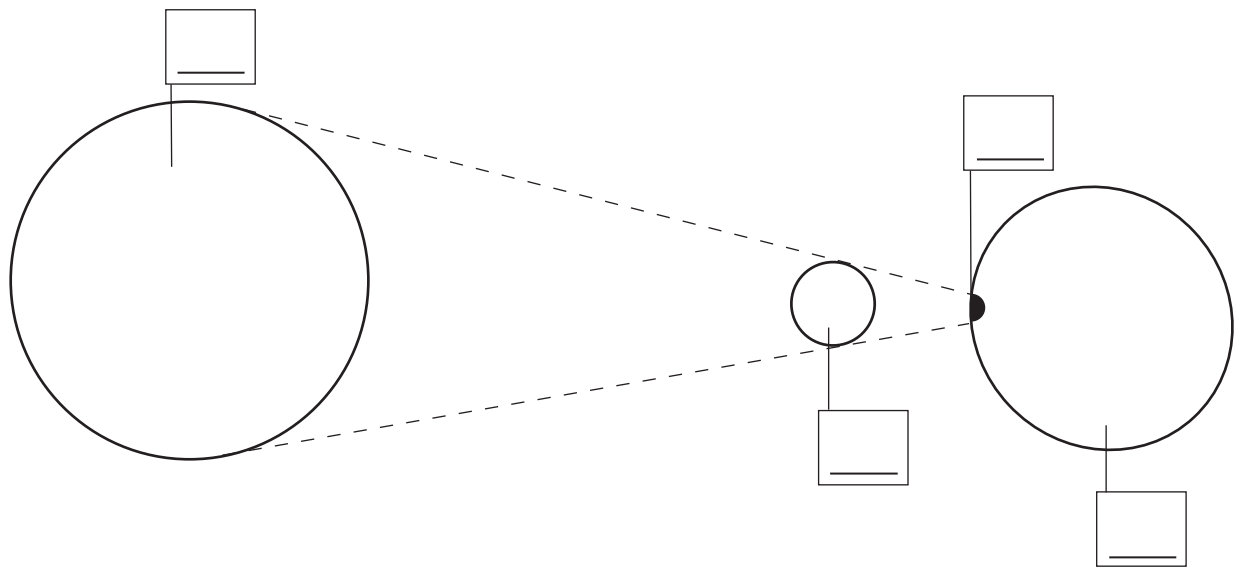

not to scale

3a
1 mark

3a
1 mark

- (b) Scientists discovered a regular cycle of eclipses. It is called the Saros cycle. The table below shows the dates of some eclipses in this cycle.

Complete the table by predicting the date of the next eclipse in the Saros cycle.

eclipse	date
eclipse 1	20th July 1963
eclipse 2	31st July 1981
eclipse 3	11th August 1999
eclipse 4	

3b
1 mark

3b
1 mark

4. The diagram below shows an organism called Euglena. It is made of only one cell. It lives in ponds and streams. Euglena have features of both plants and animals.

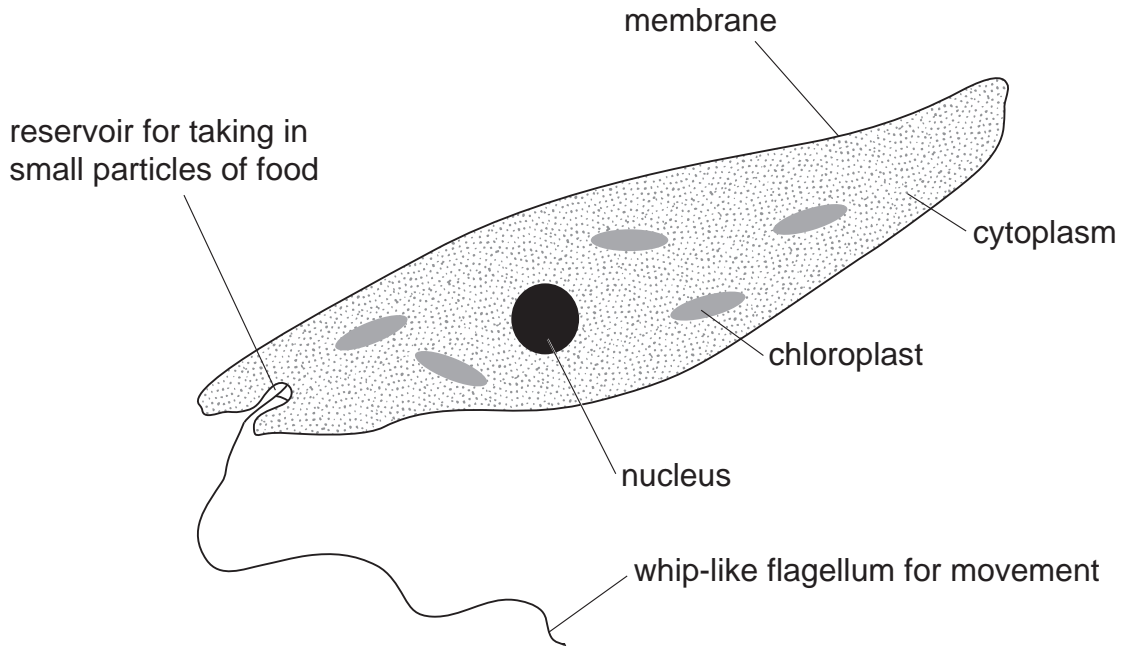

- (a) Look at the diagram of Euglena.

Give **two** pieces of evidence which suggest it is an **animal** cell and **not** a plant cell.

1. _____
2. _____

4a
1 mark

4a
1 mark

- (b) Plant cells can carry out photosynthesis. How can you tell from the diagram that Euglena can carry out photosynthesis?

4b
1 mark

- (c) Complete the word equation for photosynthesis.

carbon dioxide + _____ → glucose + _____

4c
1 mark

4c
1 mark

maximum 9 marks

5. Joe makes two bridges from strips of cardboard cut as shown.

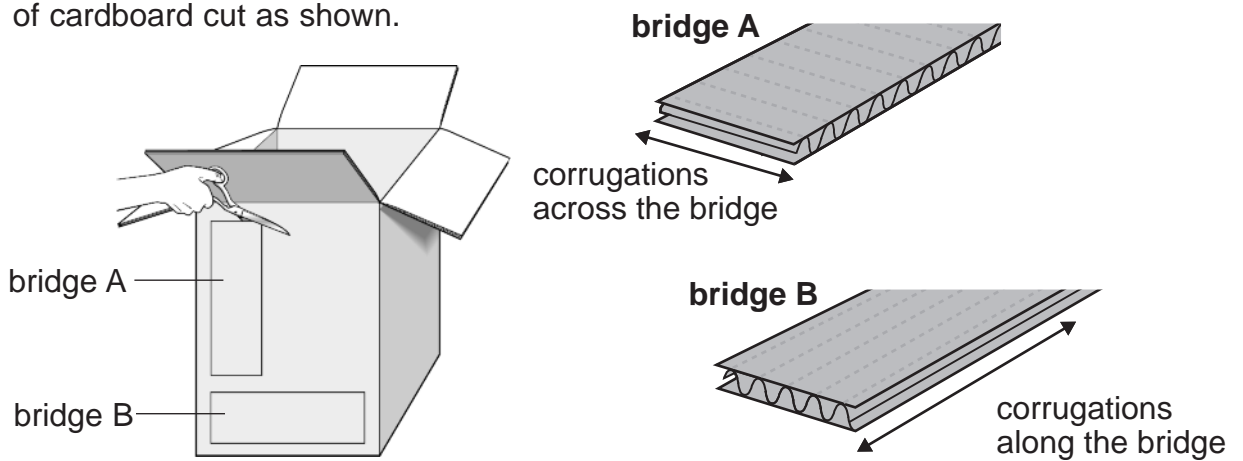

Joe tests the bridges by adding masses to them. He measures the distance from the bench to the bottom of each bridge for different masses as shown.

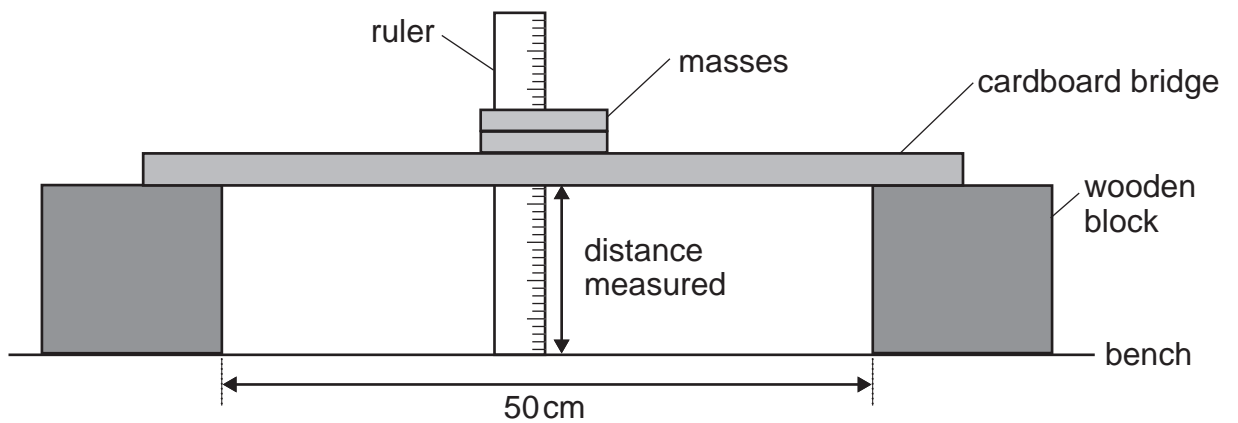

5a

1 mark

(a) Suggest **two** things Joe must do to make his test fair.

1. _____

2. _____

5a

1 mark

Here are Joe's results.

mass added to bridge (g)	distance from bench to bottom of bridge (cm)	
	bridge A	bridge B
0	7.2	7.2
100	7.1	7.0
200	7.0	6.5
250	6.8	6.1
300	3.0	5.6
350	0.0	5.0

- (b) (i) Joe put 325 g on each bridge.
Using the results table, estimate the distance from each bridge to the bench.

bridge A _____ cm

bridge B _____ cm

5bi
1 mark

- (ii) Suggest what happened to **bridge A** when it was loaded with 350 g.

5bii
1 mark

- (c) (i) Which bridge would be better for carrying a **200 g** toy car?
Tick the correct box.

bridge A

bridge B

Explain your answer.

5ci
1 mark

- (ii) Which bridge would be better for carrying a **300 g** toy car?
Tick the correct box.

bridge A

bridge B

Explain your answer.

5cii
1 mark

maximum 6 marks

6. (a) Amy's family are at the beach during the summer.
Amy and her sister have a bucket containing seawater and sand.



Read the following statements.
Which are **true** and which are **false**?

Tick **one** box for each statement.

	true	false
Water is a solvent for salt.	<input type="checkbox"/>	<input type="checkbox"/>
Sand sinks in water because water is more dense than sand.	<input type="checkbox"/>	<input type="checkbox"/>
When a solid dissolves in water, the solid is called a solute.	<input type="checkbox"/>	<input type="checkbox"/>

6a
1 mark

6a
1 mark

6b
1 mark

6b
1 mark

- (b) Seawater contains dissolved salt.
Describe what Amy can do to separate **and** collect pure water from seawater.

- (c) Draw a line from each of the **substances** below to the **group** that it belongs to.
Draw only **three** lines.

Draw a line from each **group** to the correct **description**.
Draw only **three** lines.

substance	group	description
seawater	compound	It contains two or more types of atoms or molecules which can be physically separated.
salt	mixture	It contains only one type of atom.
oxygen	element	Two or more types of atoms are chemically joined together.

6c
1 mark

6c
1 mark

maximum 6 marks

7. (a) The diagram below shows part of the periodic table of elements.

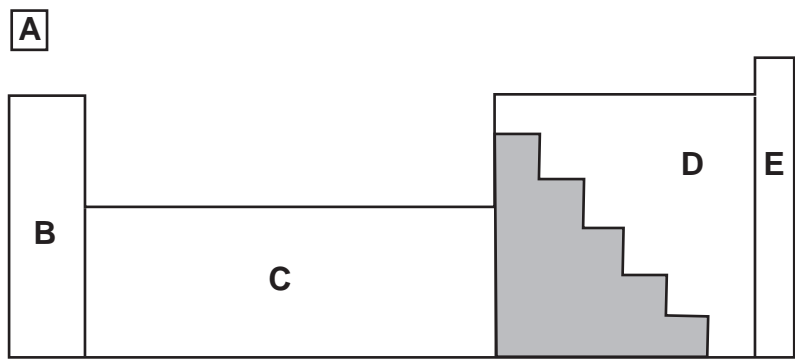

The shaded area contains **only** metal elements.

Two other areas also contain **only** metal elements.

Which areas contain only metal elements?

Tick the **two** correct boxes.

^{7a}
 A
 B
 C
 D
 E

1 mark

(b) Copper is a metal.

At room temperature copper is a strong solid.

Give **two** other properties of copper that show it is a metal.

^{7b}

1 mark

1. _____

^{7b}

1 mark

2. _____

- (c) When copper metal is heated it reacts with a gas in air.

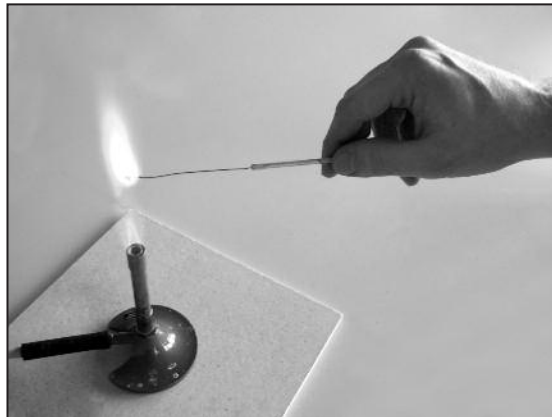

What is the chemical name of the **product** formed when copper reacts with a gas in air?

7c
1 mark

- (d) Which statement below describes what happens in a **chemical change** but **not** in a physical change?

Tick the correct box.

The product is a solid.

The change only happens at a high temperature.

The atoms have combined in a different way to make a new substance.

The types of atoms at the start are the same as in the end product.

7d
1 mark

maximum 5 marks

8. The dentist's leaflet below shows how plaque causes tooth decay.

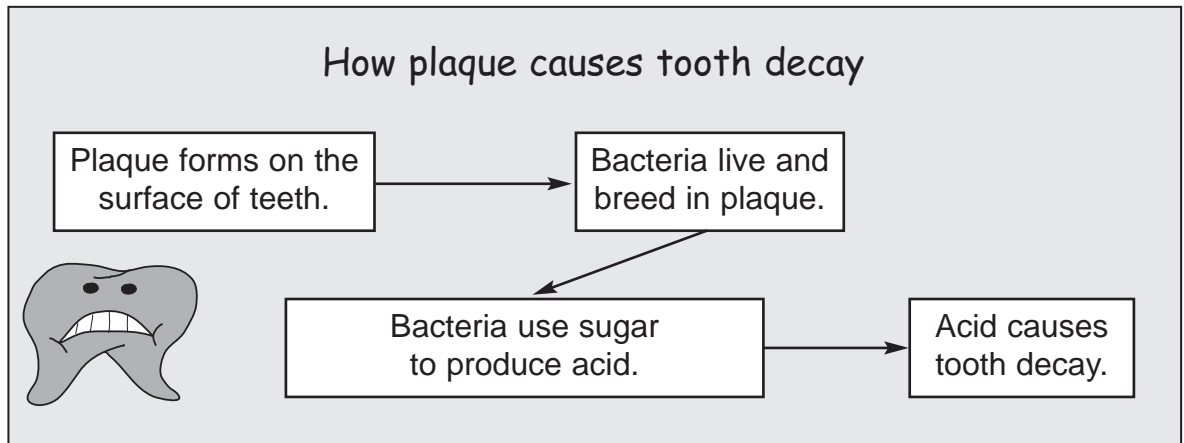

(a) (i) Explain how reducing the amount of plaque can reduce tooth decay. Use the leaflet to help you.

8ai

1 mark

8ai

1 mark

(ii) Using an alkaline toothpaste also reduces tooth decay. Give the reason for this.

8aii

1 mark

(b) A group of boys wanted to find out how well plaque is removed by brushing teeth.

Every day, before they brushed their teeth, the boys chewed a tablet that stains plaque red.

Explain why the boys looked at their teeth **before and after** brushing.

8b

1 mark

(c) The diagram below shows teeth with the plaque stained.

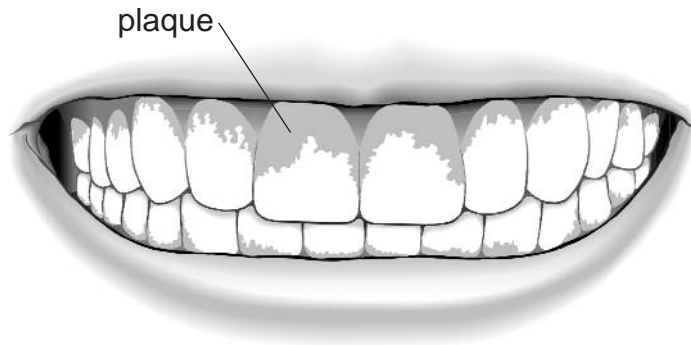

The boys used a grid drawn on clear plastic to measure the area of the plaque on their teeth.

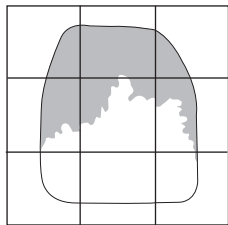

A

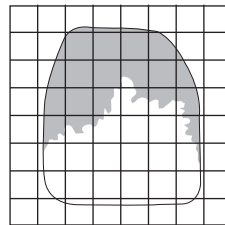

B

(i) Grid B is better than grid A for measuring the area of plaque.

Why is a grid with smaller squares better for measuring the area of plaque?

8ci
1 mark

(ii) The squares on grid B represent 1 mm².

Use grid B to estimate the area of the tooth covered by plaque.

_____ mm²

8cii
1 mark

maximum 6 marks

9. Jane stored some milk at room temperature for five days in a sealed container. She used a pH sensor and data logger to record the pH of the milk for 5 days.

Her results are shown below.

graph 1

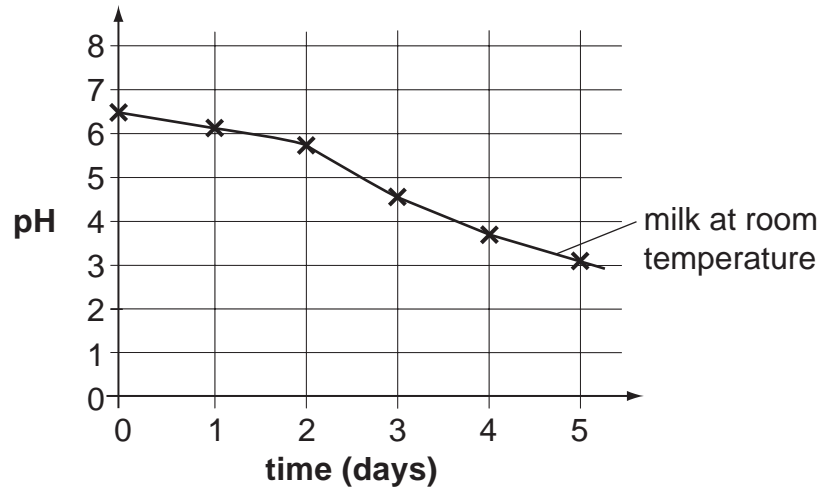

- (a) Jane predicted that the number of live bacteria in the milk would change as shown below.

graph 2

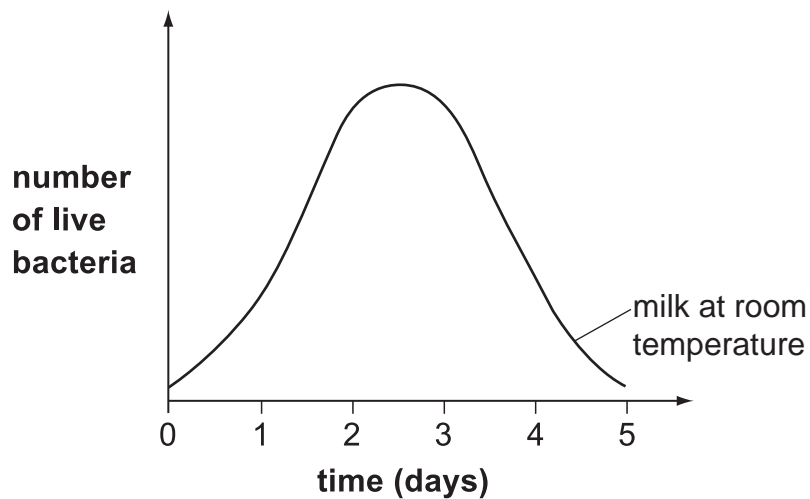

- (i) Suggest one reason why the number of live bacteria would start to decrease after 3 days.



9ai

1 mark

(ii) What evidence from **graph 1** suggests that there were still some live bacteria in the milk on day 5?

9ai
1 mark

(b) Jane put some fresh milk in a sealed container in the fridge. She measured the pH of the milk every day for five days.

(i) On **graph 3** below, draw a line to show the pH of the **refrigerated milk** for five days.

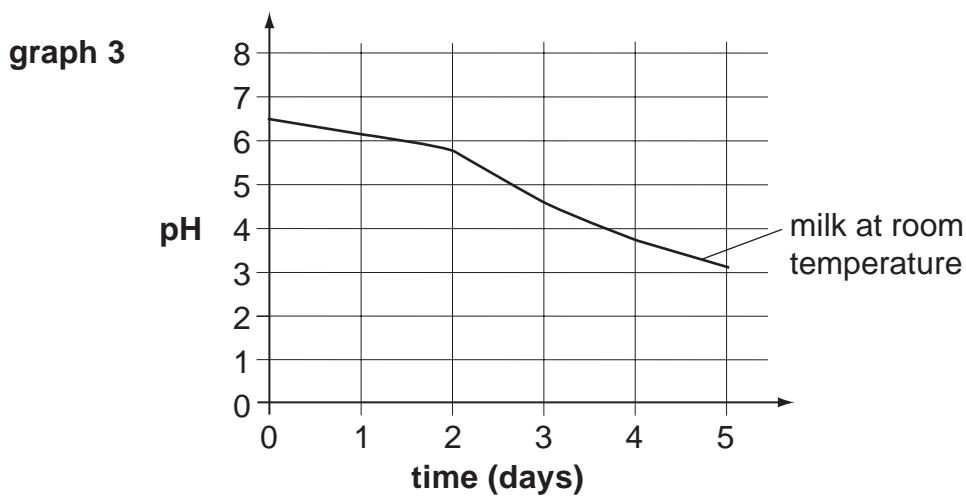

9bi
1 mark

9bi
1 mark

(ii) On **graph 4** below, draw a line to predict how the number of live bacteria in **refrigerated milk** will change over five days.

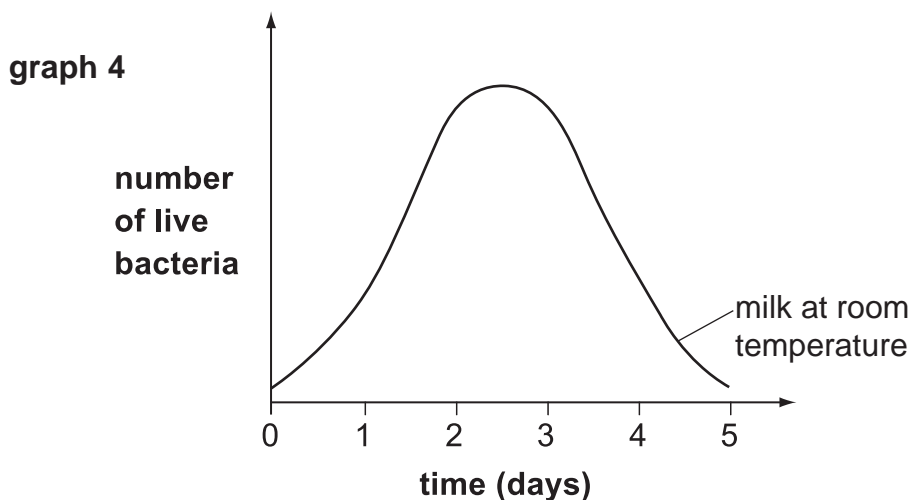

9bii
1 mark

maximum 5 marks

10. (a) Pineapple juice contains a substance that speeds up the digestion of protein.

(i) What is the name for substances that speed up digestion?

(ii) What happens to a molecule of protein during digestion?

10ai
1 mark

10aai
1 mark

(b) Asim did an experiment to investigate the digestion of gelatin. Gelatin is the protein in jelly. In test tubes A and B he used one cube of jelly in each. In test tube C he used one cube of jelly that he had chopped up.

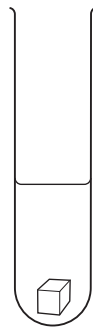

A

5 g jelly cube
+
15 cm³
cold water



B

5 g jelly cube
+
15 cm³ fresh
pineapple
juice



C

5 g jelly cube
chopped into
pieces
+
15 cm³ fresh
pineapple
juice

He recorded how long it took for the jelly to be digested in each test tube. The table below shows his results.

test tube	result
A	not digested after 2 hours
B	jelly digested in 2 hours
C	jelly digested in 1 hour

(i) What was the purpose of test tube A?





10bi
1 mark

(ii) It is helpful to chew your food.
How do the results in test tube C show this?

10bii
1 mark

(c) The substances that speed up digestion stop working when they have been boiled.

(i) What does Asim need to put in a fourth test tube to test this in his experiment? Label test tube D.
Test tubes A, B and C contain the same as in the first experiment.

			
A	B	C	D
5 g jelly cube + 15 cm ³ cold water	5 g jelly cube + 15 cm ³ fresh pineapple juice	5 g jelly cube chopped into pieces + 15 cm ³ fresh pineapple juice	_____
			+

10ci
1 mark

10ci
1 mark

(ii) Predict what Asim would observe in test tube D after 2 hours.

10cii
1 mark

maximum 7 marks

11. (a) The fire extinguisher below contains a compound called sodium hydrogencarbonate.



contains sodium
hydrogencarbonate
powder

The formula for sodium hydrogencarbonate is NaHCO_3 .

When sodium hydrogencarbonate is heated it breaks down to produce carbon dioxide, water and a compound with the formula Na_2CO_3 .

This is shown in the equation below.

- (i) Complete the word equation below.

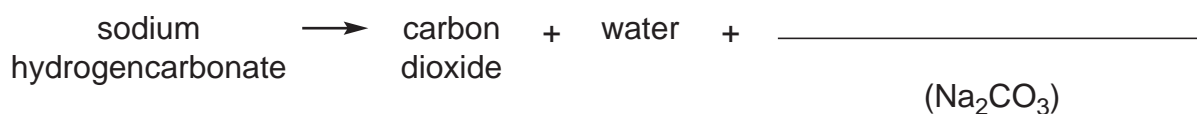

- (ii) Complete the table below to show the mass of water produced when 168 g of sodium hydrogencarbonate breaks down completely.

compound	reactant or product	mass (g)
sodium hydrogencarbonate	reactant	168
carbon dioxide	product	44
water	product	
Na_2CO_3	product	106

- (iii) How much carbon dioxide is produced when 336 g of sodium hydrogencarbonate breaks down completely?

_____ g

(b) The diagram below shows two other types of fire extinguisher.



contains carbon dioxide gas



contains water

To put out a fire, you have to do one or more of the following:

- keep oxygen away from the fire
- take the heat away from the fire
- take the fuel away from the fire.

The density of carbon dioxide is about 1.8 g per 1000 cm³.

The density of air is about 1.2 g per 1000 cm³.

(i) Use the information above to explain why carbon dioxide is used to put out fires.

11bi

1 mark

11bi

1 mark

(ii) When water from the fire extinguisher is sprayed over a fire, the water evaporates.

Why does evaporation cool the fire down?

11bii

1 mark

maximum 6 marks

12. The table below shows information about four planets.

planet	time taken to orbit the Sun (Earth years)	distance from the Sun (million km)
Mercury	0.25	60
Venus	0.5	108
Earth	1.0	150
Mars	2.0	228

The diagram below shows the orbits of the Earth, Mercury, Venus and Mars, and their position at one particular time.

The arrows show the direction in which the planets move.

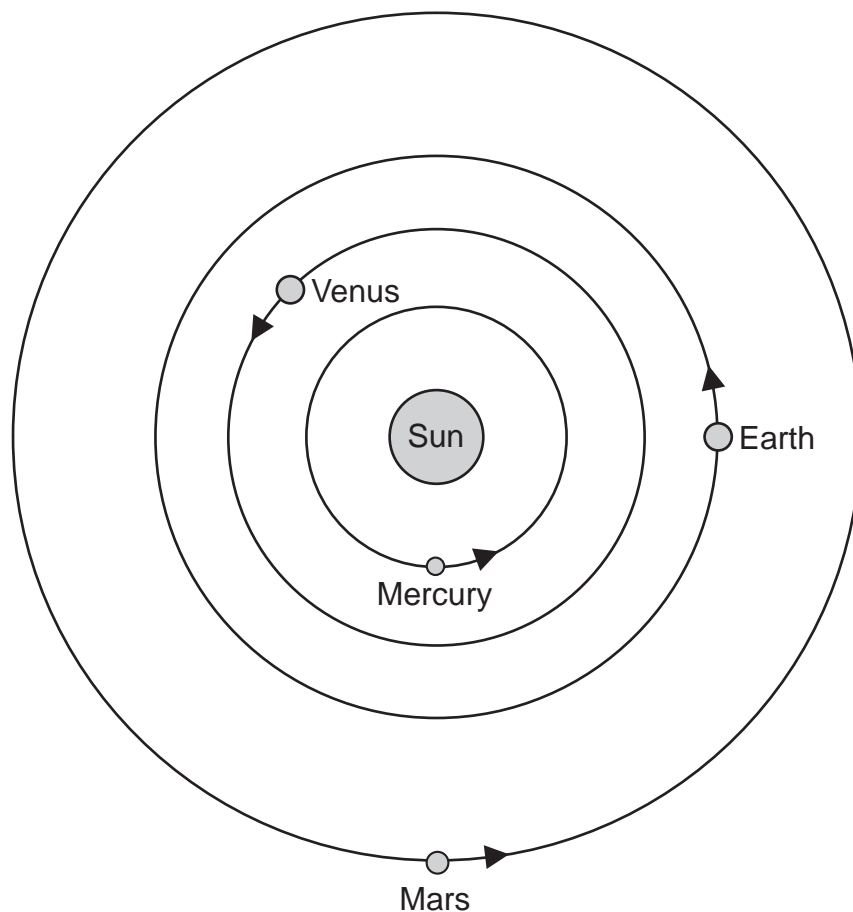

not to scale

12a
1 mark

12a
1 mark

(a) Show the position of each planet six months later by drawing a letter X on the orbit of each planet.

(b) Use the information in the table to calculate the largest and smallest distance between the Earth and Venus.

closest _____ million km

furthest _____ million km

12b
1 mark

12b
1 mark

(c) The speed of light is 300 000 km/second.
Calculate how long light takes to reach the Earth from the Sun.

_____ s

12c
1 mark

(d) The diagram below shows the path of an asteroid around the Sun.

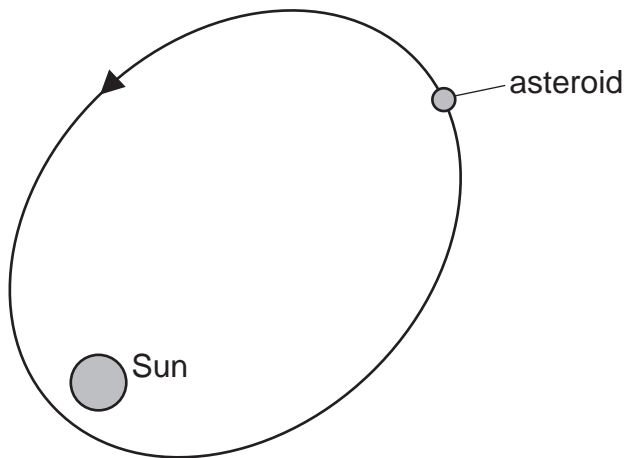

not to scale

(i) **On the path of the asteroid**, draw a letter S to show the position where the asteroid is travelling the slowest.

On the path of the asteroid, draw a letter F to show the position where the asteroid is travelling the fastest.

(ii) Explain why the speed of the asteroid changes.

12di
1 mark

12dii
1 mark

maximum 7 marks

13. (a) The drawings below show an old and a modern variety of wheat plant.

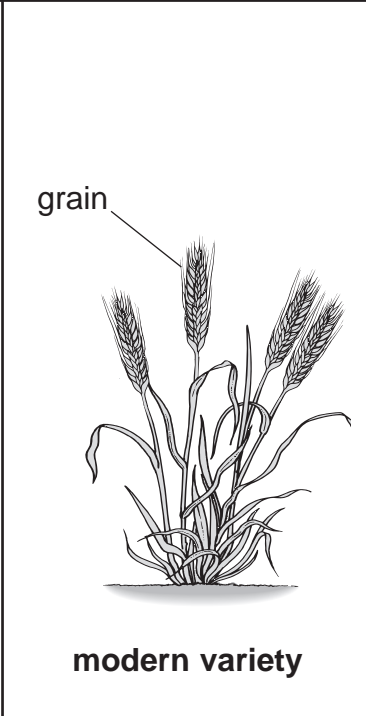
	 <p>old variety</p>	 <p>modern variety</p>
average mass of grain produced per m² (kg)	0.5	0.8
average length of stalk (cm)	145	78

Glucose produced by the wheat plants is used:

- to provide energy for growth
- to make cell walls
- to make starch which is stored in the grain.

Give **one** reason why modern wheat plants with short stalks can store more starch in the grain. Use the drawings and information.



13a

1 mark

(b) A plant breeder wants to use selective breeding to produce corn with short stalks and a high mass of grain. He could use the following varieties of corn:

variety A
long stalks
high mass of grain

variety B
short stalks
low mass of grain

variety C
long stalks
low mass of grain

(i) What would the plant breeder need to do to make sure he always produced corn with short stalks and a high mass of grain?
Describe the three steps the breeder would use.

13bi
1 mark

13bi
1 mark

13bi
1 mark

(ii) Suggest **one** other characteristic that farmers might like corn plants to have to increase the amount of corn produced.

13bii
1 mark

END OF TEST

maximum 5 marks

[BLANK PAGE]

[BLANK PAGE]

